









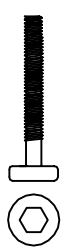

FITTINGS

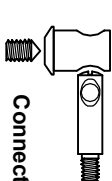
A		M6 x 35 Screw	X4
B		Chrome Support Washer (φ 9x22)	X4
C		M8 x110 Hexagon Head Screw	X4
D		M8 HALF ROUND NUTS	X4
E		Connector	X4
F		φ 8x30 WOODEN DOWEL	X4
G		DOWEL GLUE BOTTLE(50g)	X1
H		φ 35mm	X4
I		Allen Key(5MM)	X1
J		Mini Fix	X4
K		M6 x 20 Screw	X8

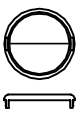

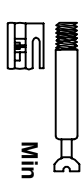
STEP 1

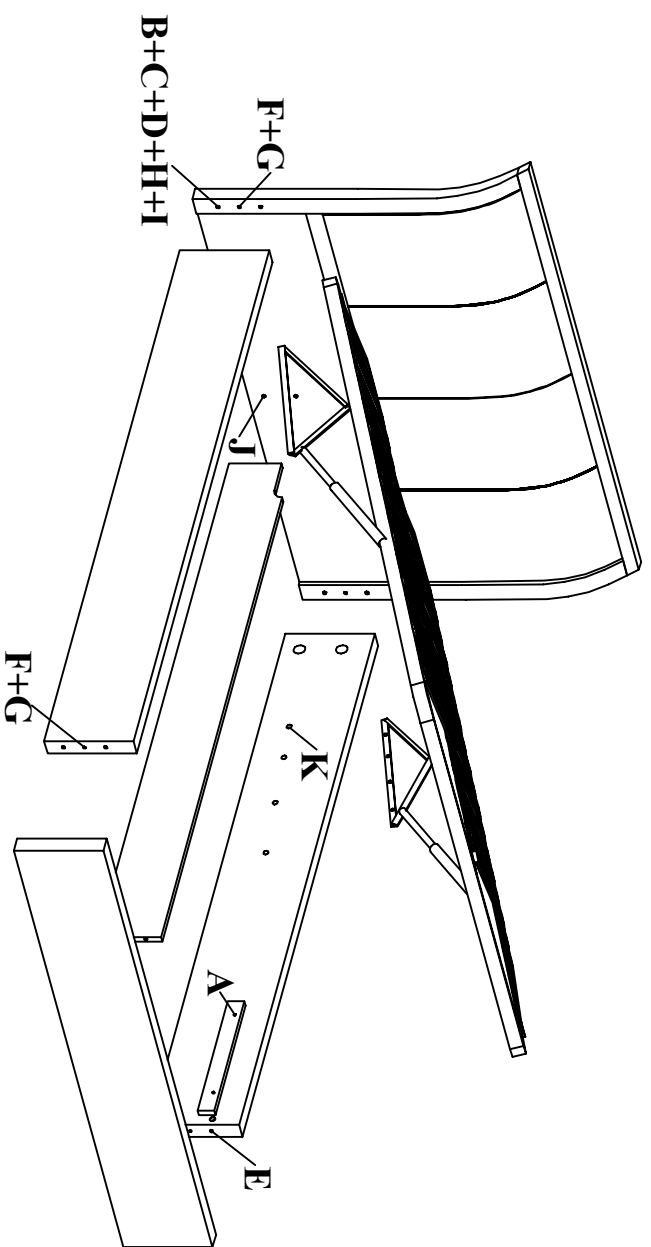
STEP 2

STEP 3

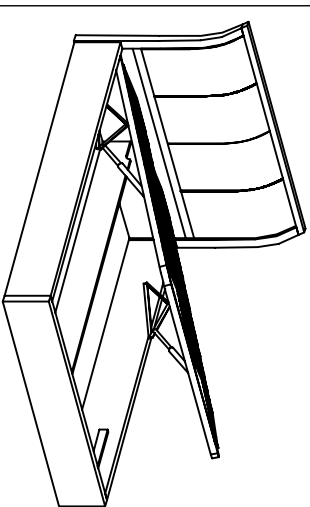
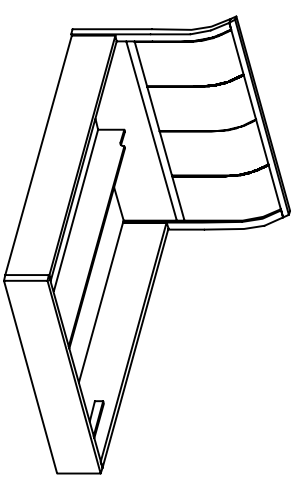
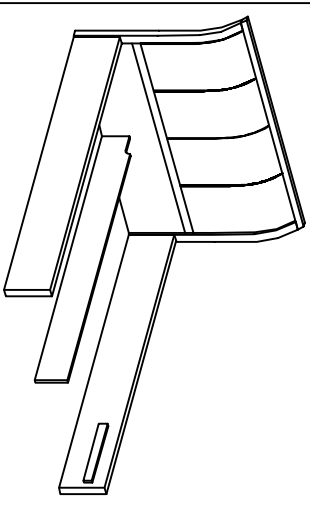

TITLE:

ASSEMBLY DRAWING:

ITEM:

6BED(A1047-B-N01)

SCALE: N.T.S

DATE: 2006-8-3

DRAWING BY: JMW

DRAWING NO.: